

SPECIFICATION

- Part No. : **GP.1575.25.2.A.02**
- Product Name : 2mm GPS/Galileo Patch Antenna
- Features : 25mm x 25mm x 2mm
RoHS Compliant



1. Introduction

This miniaturized ceramic GPS/GALILEO patch antenna is based on smart *XtremeGain*™ technology. It is mounted via pin and double-sided adhesive and has been selected as optimal solution for the customer device environment.

Precaution for Use

- The metal pattern on ceramic patch is silver electrode
- Please do not use corrosion gas (sulfur gas, chlorine gas) in the atmosphere.
- Please do not direct solder anything onto the silver electrode of the patch

2. Specification

Parameter	Specification
Range of Receiving Frequency	1575.42MHz ± 2MHz
Bandwidth	5 MHz (10dB Return Loss)
VSWR	1.5 max
Gain at Zenith	+2.0 dBic typ.
Gain at 10° elevation	-4.0 dBic typ.
Axial Ratio	3.0 dB max
Polarization	Right Hand Circular Polarization
Weight	8 g
Operating Temperature	-40°C to +85°C
Operating Temperature	-40°C to +85°C

*All electrical properties were tested with the antenna mounted on 35 x 35mm ground plane

3. S11 Electrical Property

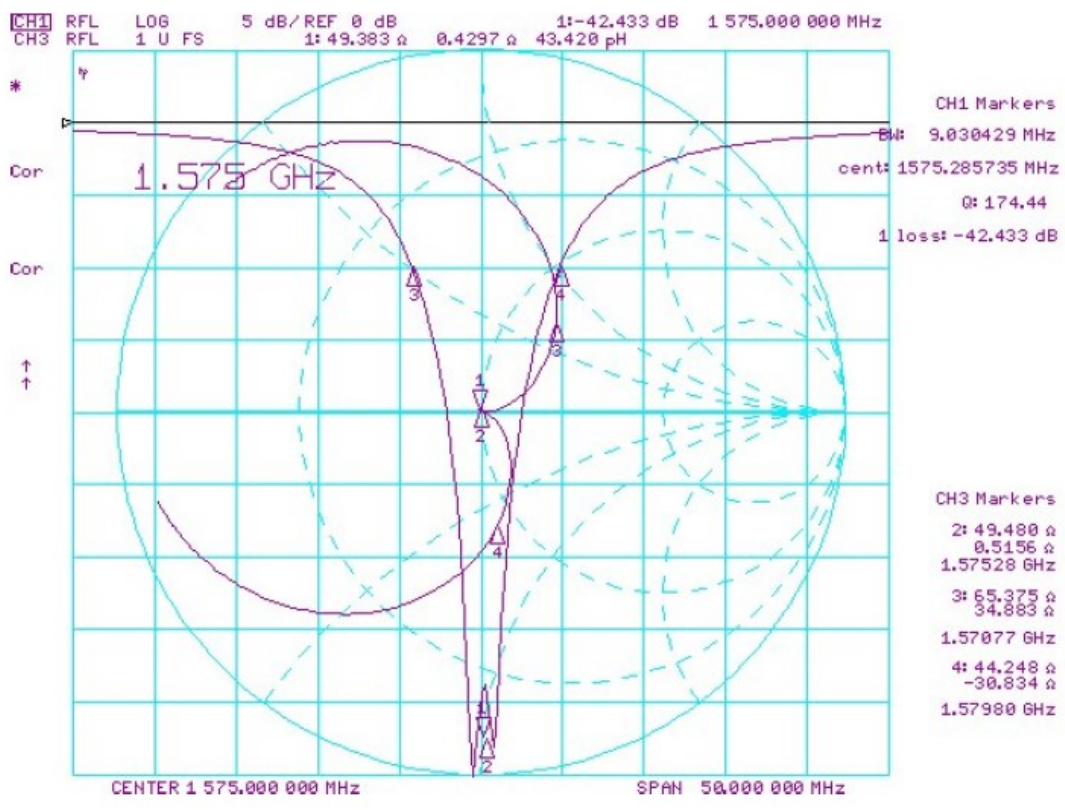

4. Radiation Pattern

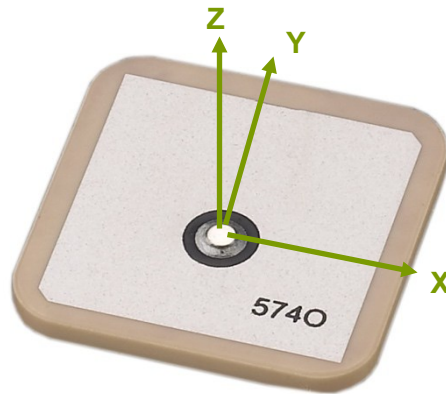

Test Plane	Frequency	Peak Gain	Min. Gain	Average Gain
XZ	1575.42MHz	0.0dBi @ 356°	-11.7dBi @ 205	-3.8dBi
YZ	1575.42MHz	0.0dBi @ 8°	-19.4dBi @ 215	-4.4dBi

4.1.XZ Radiation Pattern

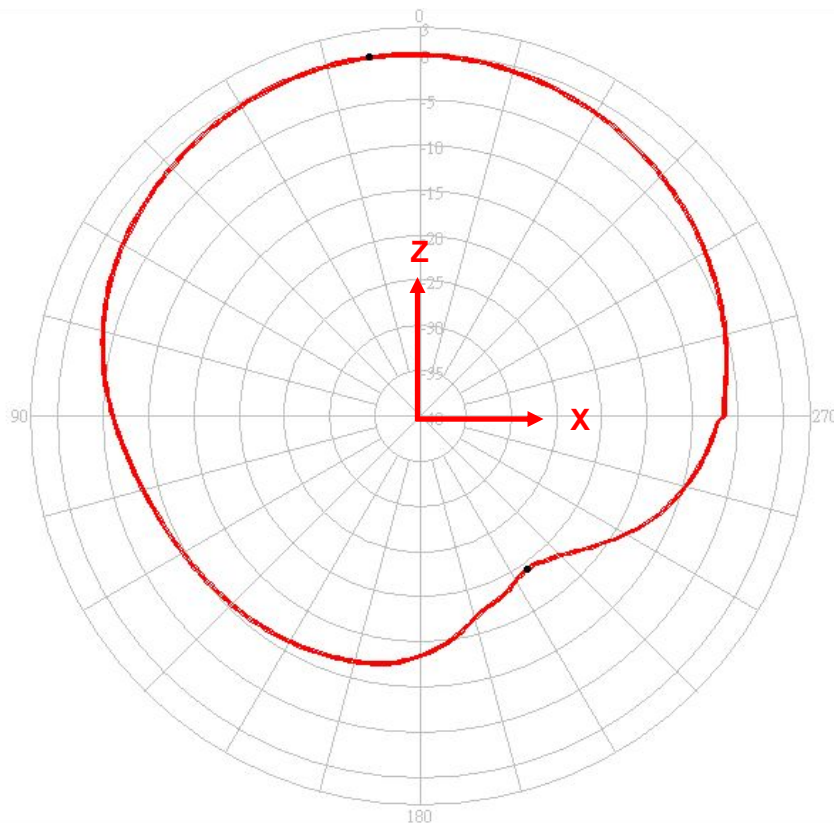

4.2.YZ Radiation pattern

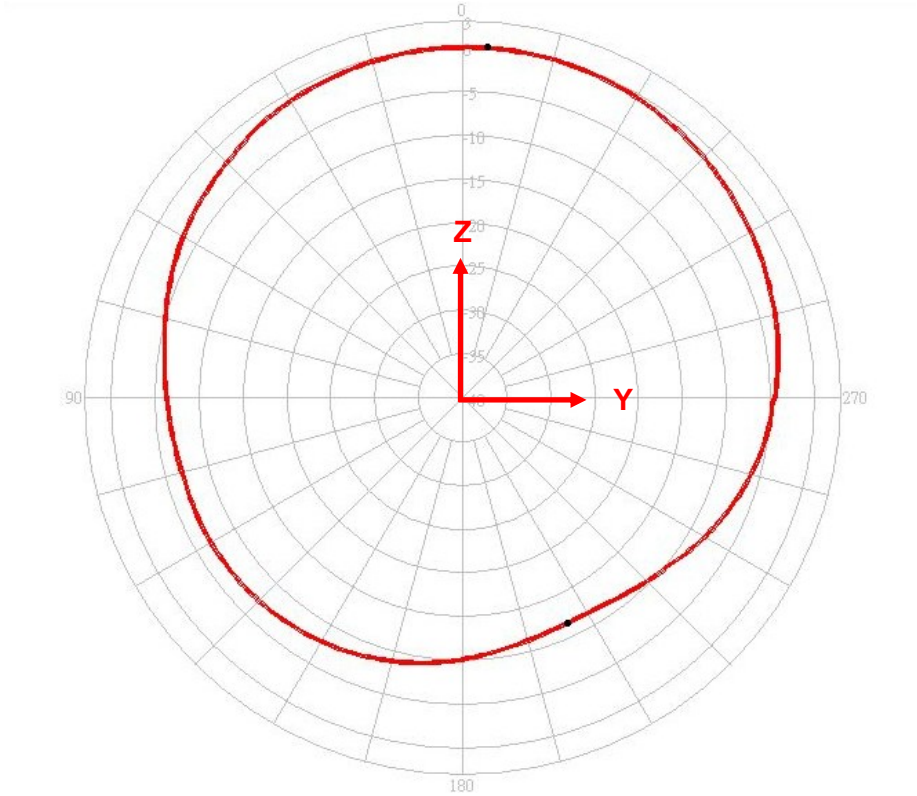

5. Mechanical Drawing

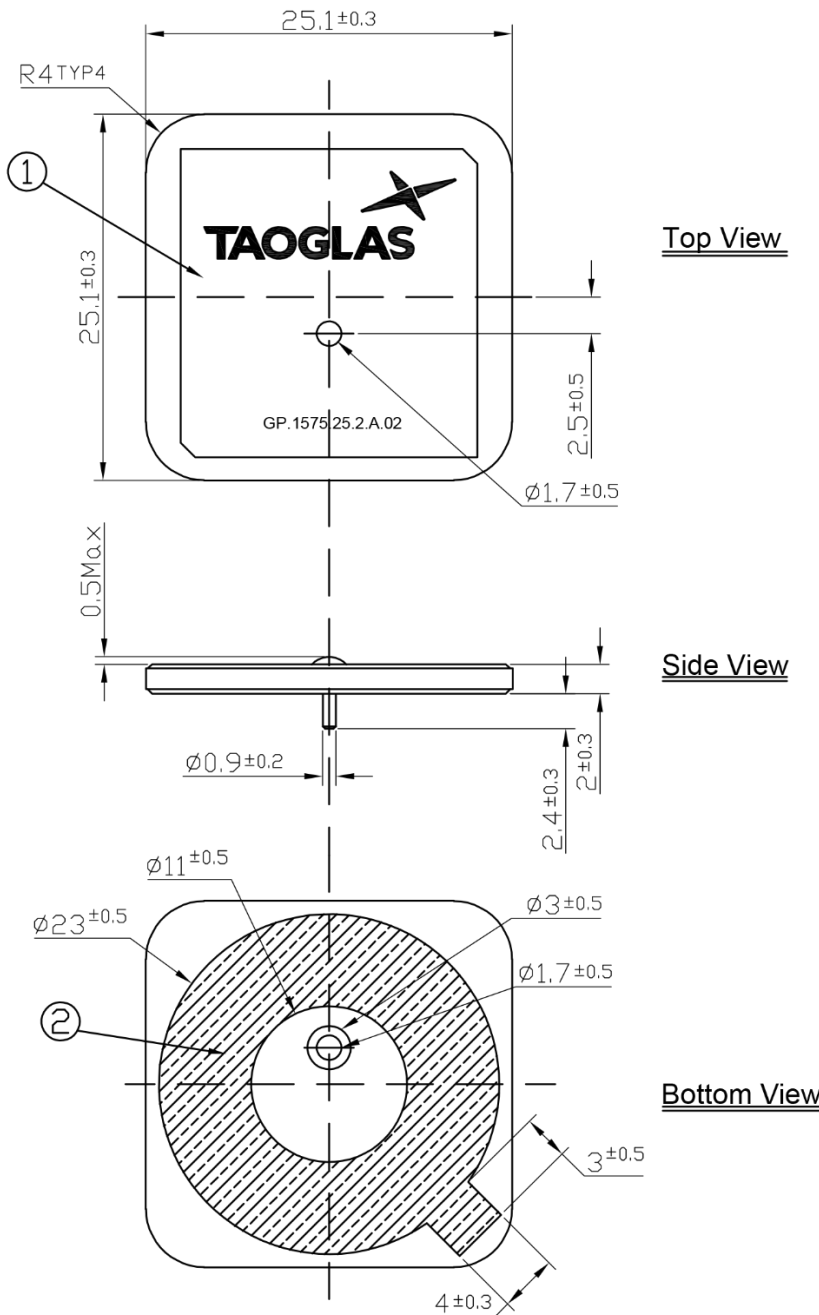

NOTES: 1. Double sided adhesive area 

	Name	P/N	Material	Finish	QTY
1	Patch 25x25x2	001013C070007A	Ceramic	Clear	1
2	Double sided Adhesive	001012L060007A	NITTO 5015	White Linter	1

6. PCB Footprint Recommendation

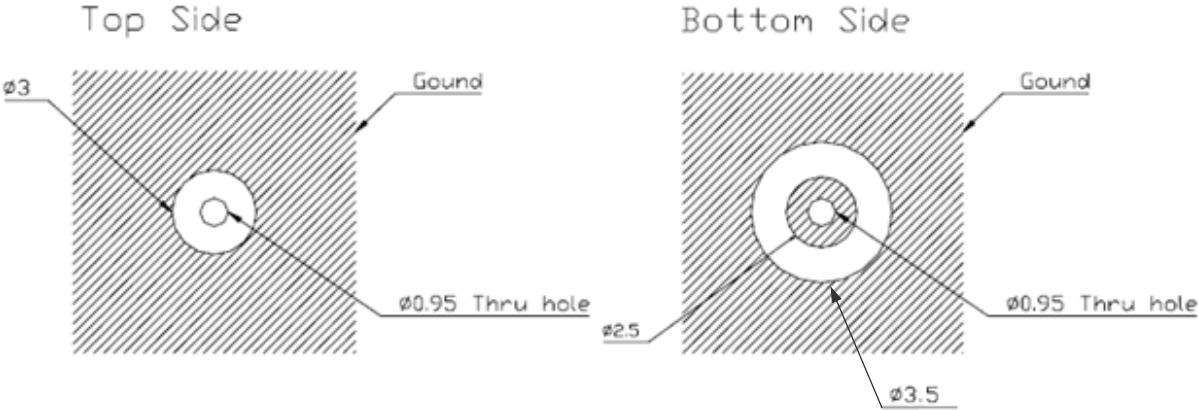

7. Packaging

- 50 pieces per tray.
- 4 trays per box = 200 pieces per box
- 4 box per carton = 800 piece per carton

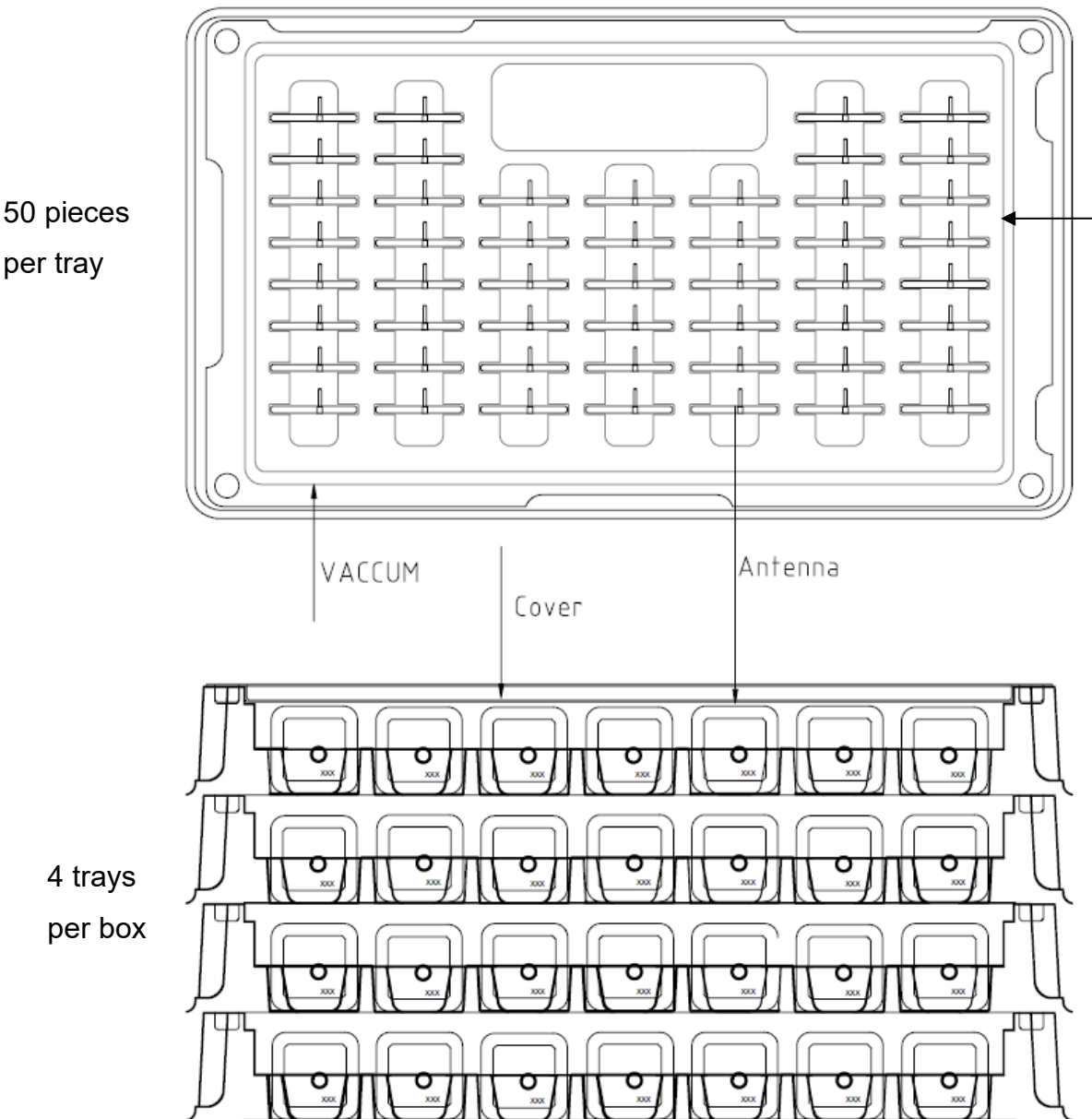

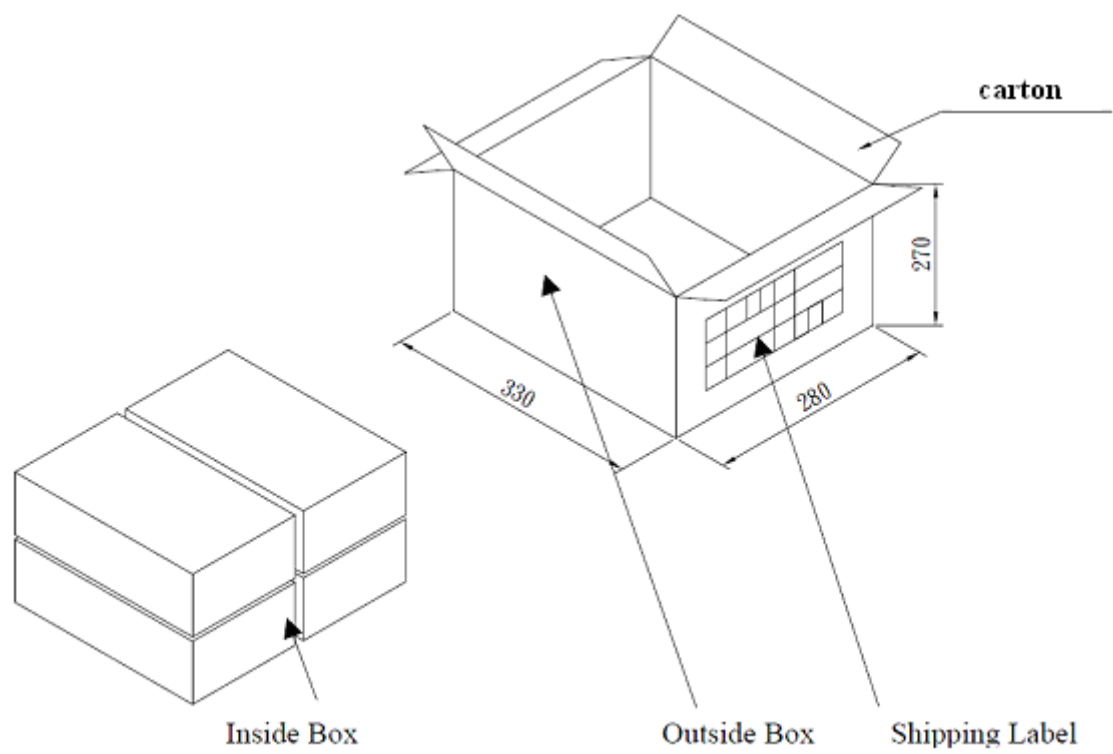
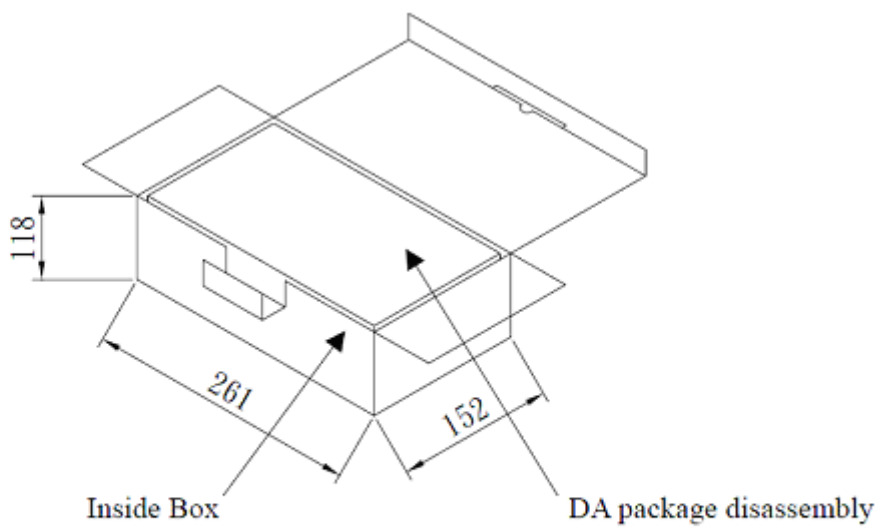

Unit : mm

Taoglas makes no warranties based on the accuracy or completeness of the contents of this document and reserves the right to make changes to specifications and product descriptions at any time without notice. Taoglas reserves all rights to this document and the information contained herein.

Reproduction, use or disclosure to third parties without express permission is strictly prohibited.

Copyright © Taoglas Ltd.